

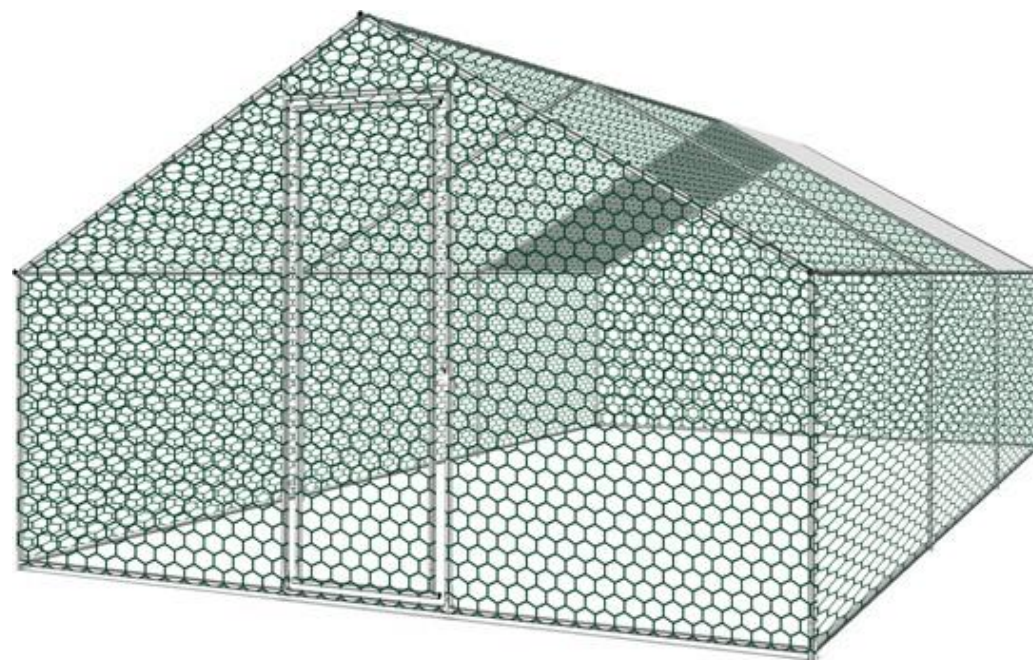























ENCLOS

3x6x2m

NOTICE DE MONTAGE

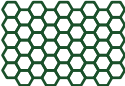

PARTIE	DESCRIPTION	PHOTO	QUANTITE
①	1870mm		15
②	1410mm		4
③	970mm		8
④	1650mm		8
⑤	560mm		2
⑥	660mm		1
D1			1
D2	1470mm		1
D3	1750mm		1
A			4
B			2
C			4

PARTIE	DESCRIPTION	PHOTO	QUANTITE
D			6
E			6
F			2
G			4
H			4
I			4
J			10
K			8
L			/
M			/
N			24mx2
O			1

1.ASSEMBLAGE DE LA BASE

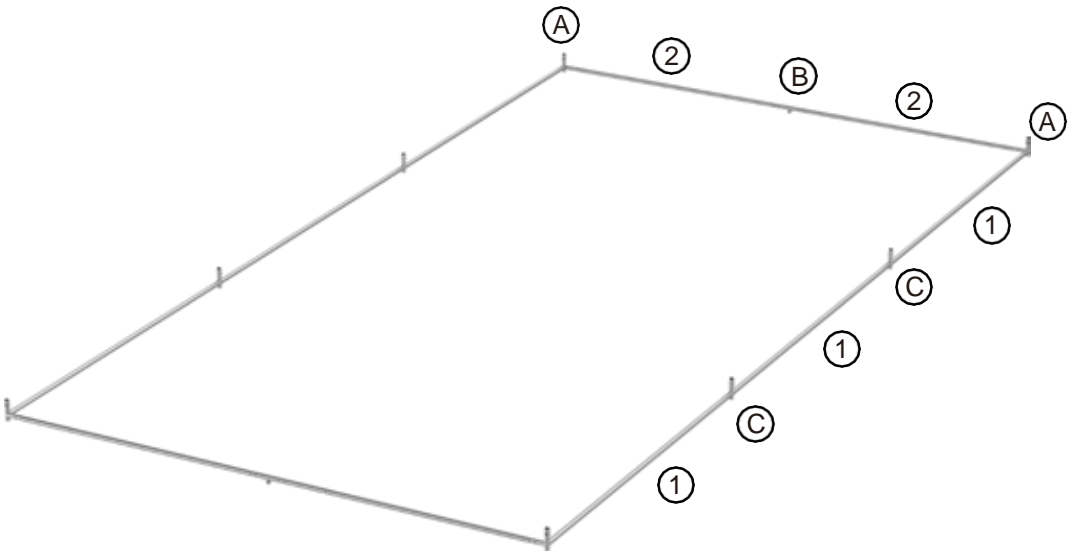
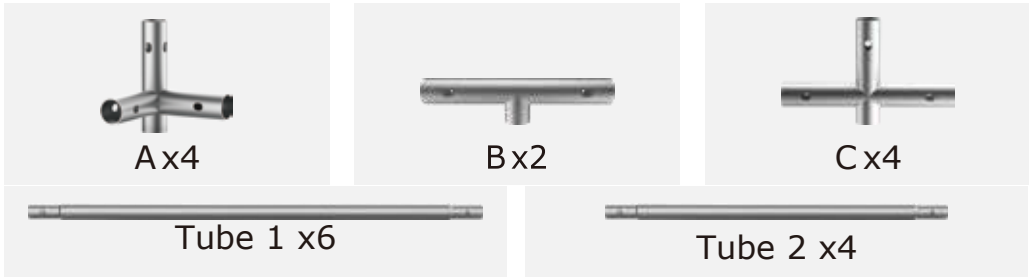

2.ASSEMBLAGE DES TUBES VERTICAUX

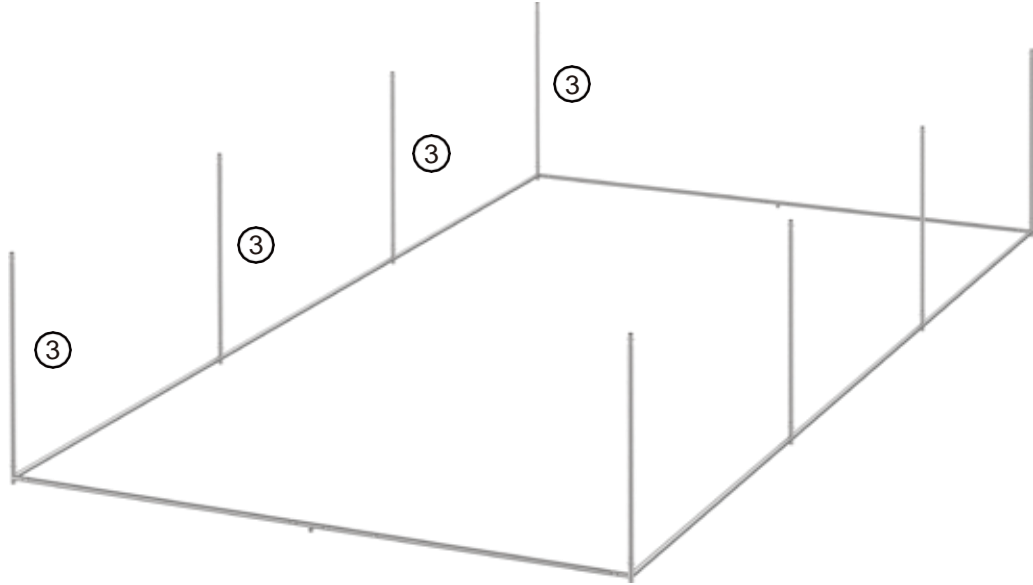
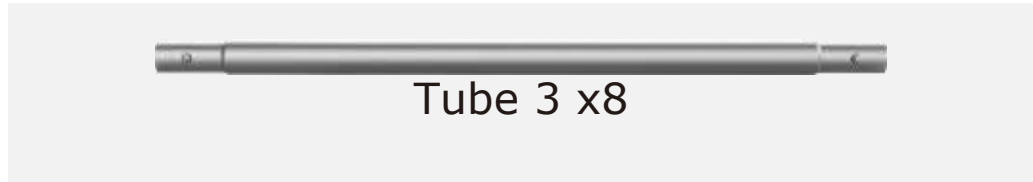

3. ASSEMBLAGE DE LA STRUCTURE DU TOIT

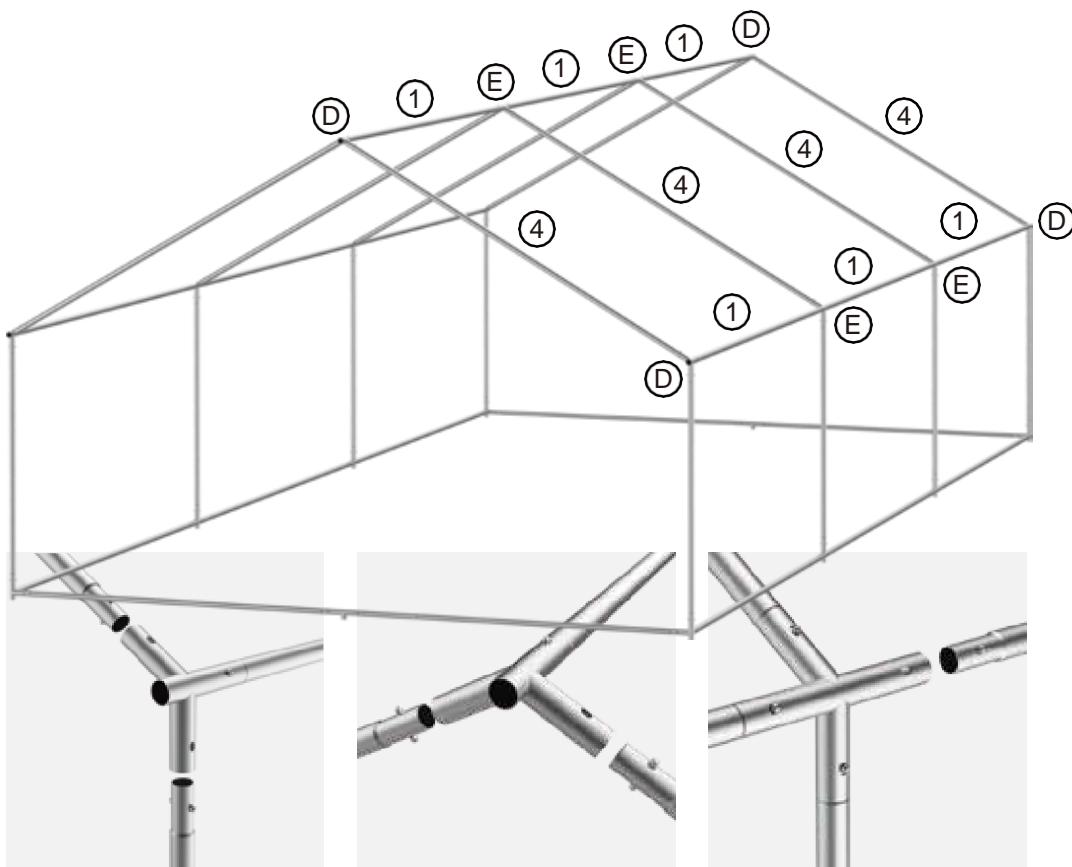
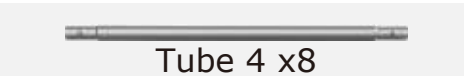
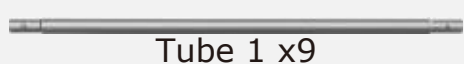

4. ASSEMBLAGE DE LA PORTE

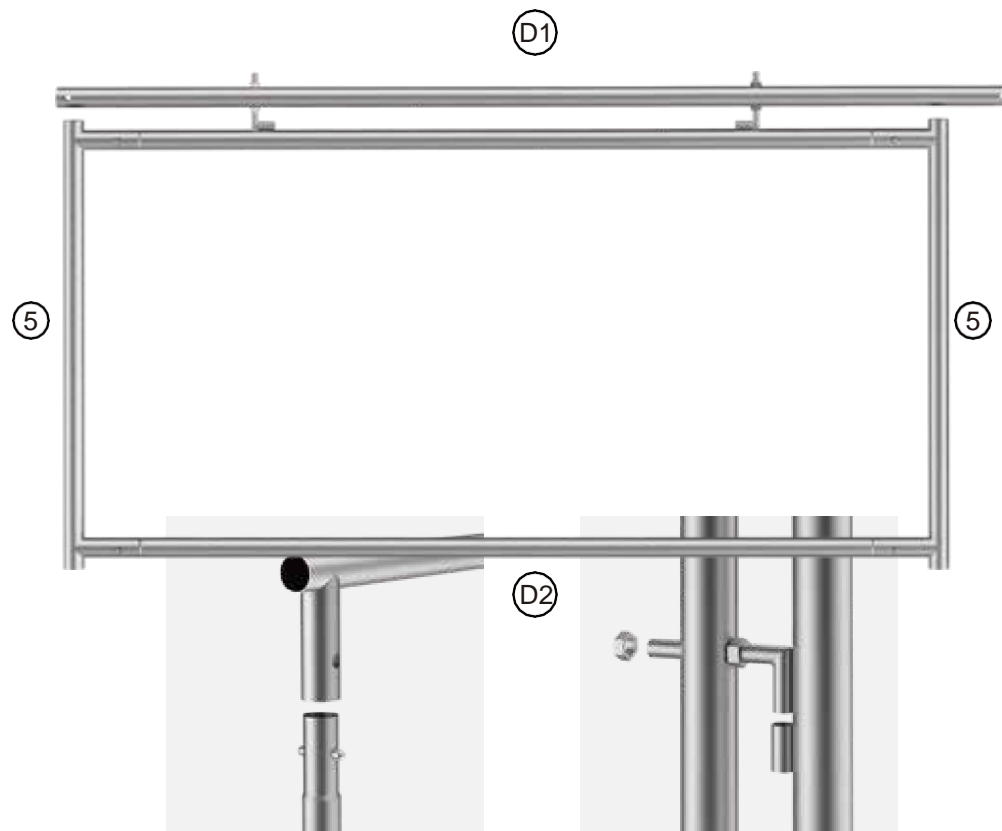
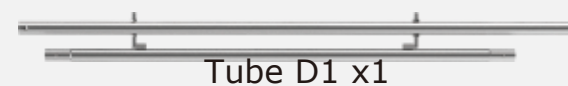
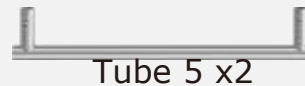

5. MISE EN PLACE DE LA PORTE

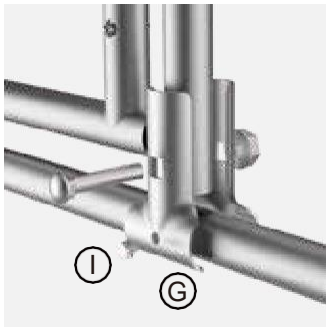
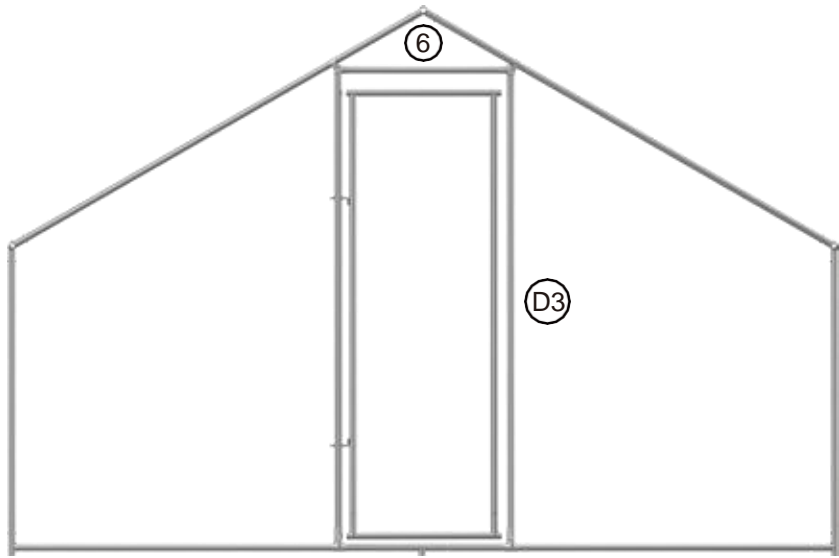

7. INSTALLATION DU GRILLAGE

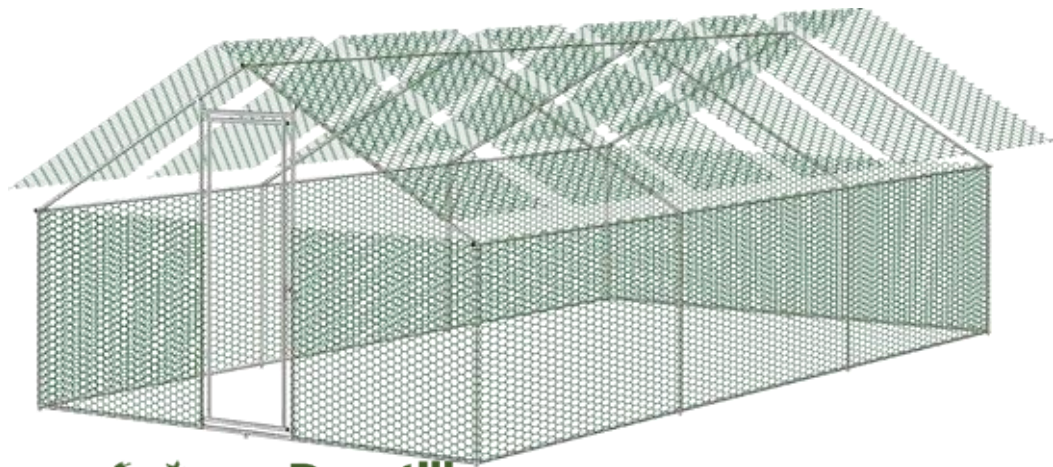
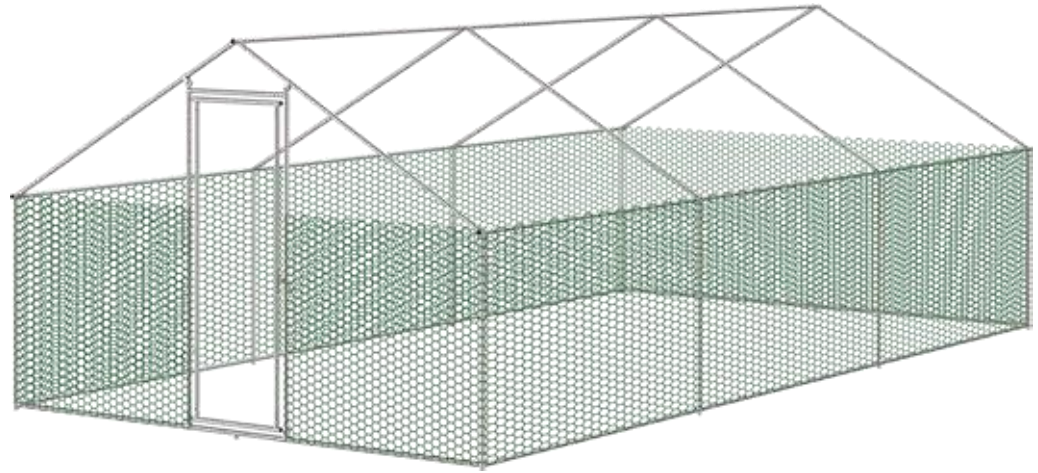

Ducatillon
www.ducatillon.com

8. INSTALLATION DU TOIT

